

AUTOMATIC SHEAR BALERS

COLMAR



Radio remote control with automatic function

EAGLE 750

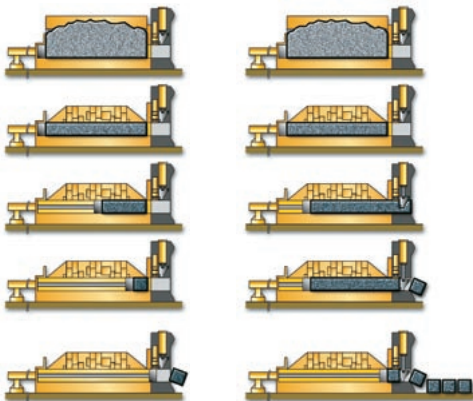

Baler mode

Shear mode

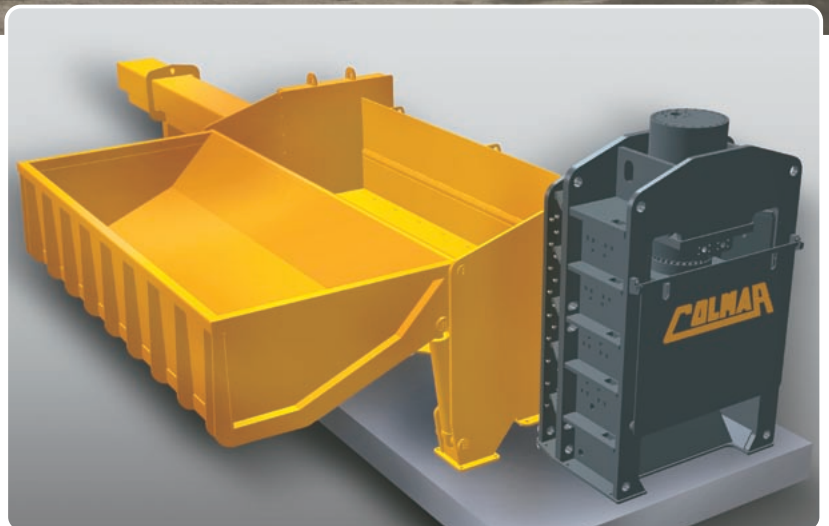

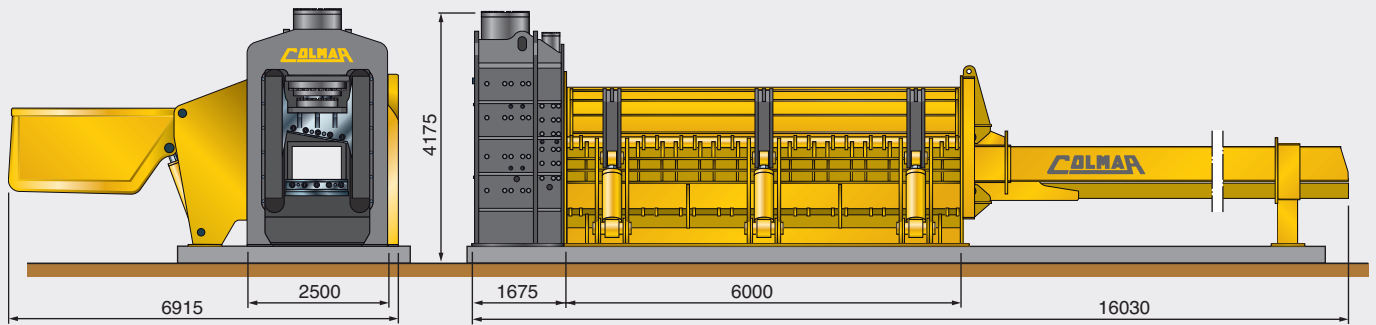

		EAGLE 750
Operating characteristics		
	Max force 1. and 2. door	350 ton/each
	Max force pushing piston	150 ton
	Blocking sheet force	170 ton
	Dimension of baled material	900 x 600 mm
	Density of baled material (*)	c.1500 kg/mc
	Max shear force	750 ton
	Shear output (*)	20,0 - 30,0 ton/h
Technical specification		
	Total weight of the machine	120.000 kg
	Length of container	6.000 mm
	Baler structure	Fe 510 D
	Container structure	Hardox® 450
	Shear structure	Fe 510 D
	Cutting blades	45NiCrMoV16
	Motors type	no.3 electric motors VEM/SEIPEE
	Motors power	270 kW (3 x 90 kW) - 1500 Rpm
	Power supply	Voltage: 380/480 V - 50/60 Hz
	Engine cooling system	forced air cooling circuit in the motors
	Hydraulic system valves	DENISON distributing block
	Operating pressure of the hydraulic system	250 bar / 350 bar
	Hydraulic oil cooling system	air/oil cooler
	Cutting blade length	1100 mm
	Shear greasing system	automatic
	Hydraulic oil tank capacity	5000 L
	Hydraulic oil circuit total capacity	7000 L
Accessories		
	Standard	RC - HB - ACC - AG - EE - P
	Optional	LBA - WH - AC - R - CTR

LBA = Loading boom arm (weight 2500Kg), RC = Remote control, HB = hydraulic bulk, ACC = Automatic compacting cycle baler + shear, P = Pre-loading, R = Radio, AG = Automatic greasing system, EE = Electric engine, WH = Hydraulic oil Webasto heating system, AC = Air conditioner, CTR = Telematic remote control.

(*) The output and bale density values may vary depending on the properties of the material treated.

Colmar reserves the right to amend the data contained within this brochure at any time.

 **COLMAR S.P.A.**
Headquarters
Via Nazionale Adriatica n.539/593
45031 Arquà Polesine (RO) ITALY
Tel. +39 0425 93 21 33 (Int. 4)
Fax +39 0425 46 50 52
www.colmarspa.com
colmarspa@colmarspa.com

 **COLMAR USA, Inc.**
U.S.A.
3790 Commerce Ct., Suite 100
Wheatfield, New York 14120
1-800-537-5204
Ph. 716 - 693 - 9877
Fax 716 - 693 - 9869
www.colmarequipment.com
info@colmarequipment.com
sales@colmarequipment.com
service@colmarequipment.com

 **COLMAR UK Ltd.**
U.K.
Unit 10, Wheel Forge Way
Ashburton Park
Ashburton Road West, Trafford Park
Manchester M17 1EH
Ph. **0161 848 8902**
Fax 0161 848 8903
www.colmarspa.com
colmaruk@colmarspa.com

 **ООО COLMAR БОСТОК**
RUSSIA
115088 Moscow,
Yuzhnoportovaya ul.7
Ph. +7 095 5405538
Fax +7 095 7100848
www.colmarspa.com
info@oocolmar.ru



ISO 9001 CERT. N. 1579

