

AUTOMATIC SHEAR BALERS

COLMAR



Radio remote control with automatic function

EAGLE 1250

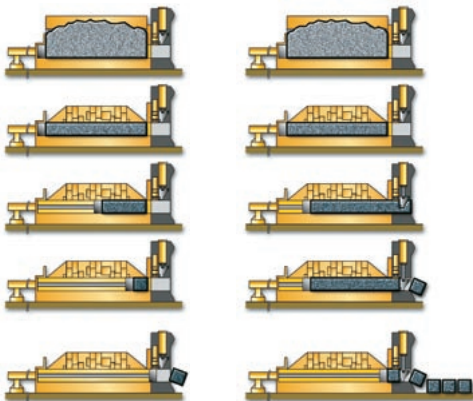

Baler mode

Shear mode

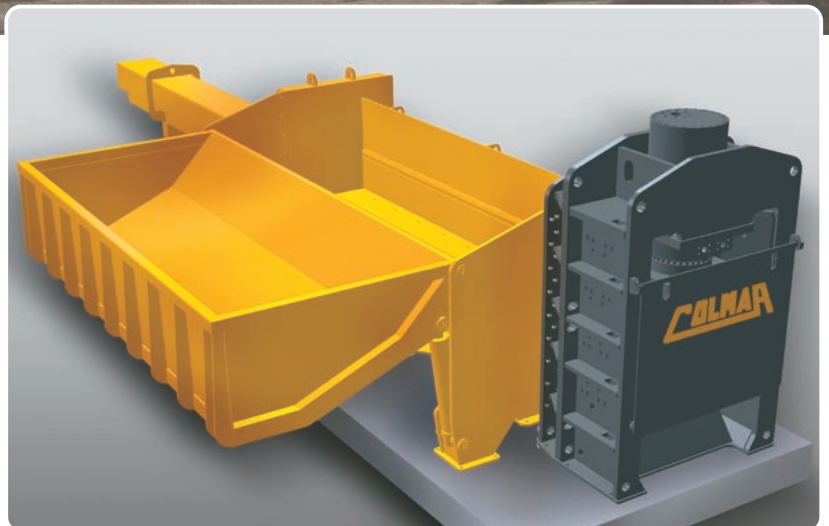

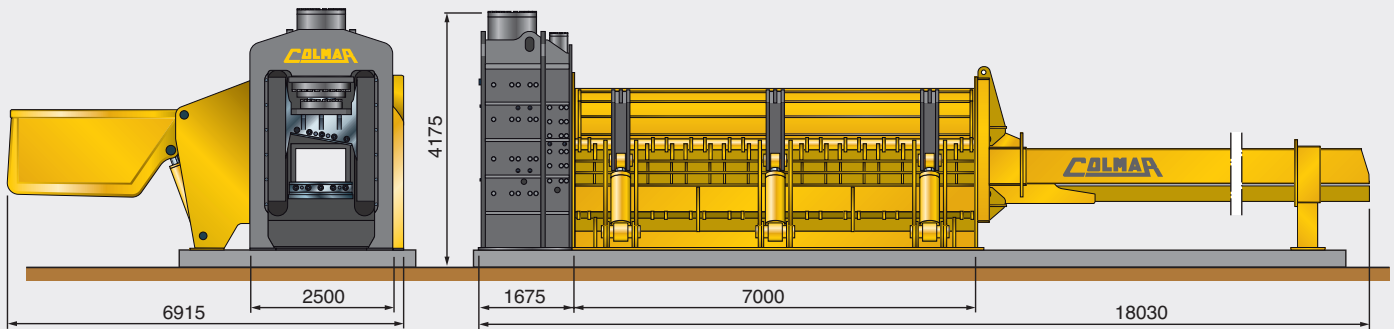

		EAGLE 1250
Operating characteristics		
Max force 1. and 2. door		480 ton/each
Max force pushing piston		180 ton
Blocking sheet force		170 ton
Dimension of baled material		900 x 600 mm
Density of baled material (*)		c.1500 kg/mc
Max shear force		1250 ton
Shear output (*)		30,0 - 50,0 ton/h
Technical specification		
Total weight of the machine		155.000 kg
Length of container		7.000 mm
Baler structure		Fe 510 D
Container structure		Hardox® 450
Shear structure		Fe 510 D
Cutting blades		45NiCrMoV16
Motors type		no.4 electric motors VEM/SEIPEE
Motors power		440 kW (4 x 110 kW) - 1500 Rpm
Power supply		Voltage: 380/480 V - 50/60 Hz
Engine cooling system		forced air cooling circuit in the motors
Hydraulic system valves		DENISON distributing block
Operating pressure of the hydraulic system		250 bar / 350 bar
Hydraulic oil cooling system		air/oil cooler
Cutting blade length		1100 mm
Shear greasing system		automatic
Hydraulic oil tank capacity		7500 L
Hydraulic oil circuit total capacity		8500 L
Accessories		
	Standard	RC - HB - ACC - AG - EE - P
	Optional	LBA - WH - AC - R - CTR

LBA = Loading boom arm (weight 2500Kg), RC = Remote control, HB = hydraulic bulk, ACC = Automatic compacting cycle baler + shear, P = Pre-loading, R = Radio, AG = Automatic greasing system, EE = Electric engine, WH = Hydraulic oil Webasto heating system, AC = Air conditioner, CTR = Telematic remote control.

(*) The output and bale density values may vary depending on the properties of the material treated.

Colmar reserves the right to amend the data contained within this brochure at any time.

 **COLMAR S.P.A.**
Headquarters
Via Nazionale Adriatica n.539/593
45031 Arquà Polesine (RO) ITALY
Tel. +39 0425 93 21 33 (Int. 4)
Fax +39 0425 46 50 52
www.colmarspa.com
colmarspa@colmarspa.com

 **COLMAR USA, Inc.**
U.S.A.
3790 Commerce Ct., Suite 100
Wheatfield, New York 14120
1-800-537-5204
Ph. 716 - 693 - 9877
Fax 716 - 693 - 9869
www.colmarequipment.com
info@colmarequipment.com
sales@colmarequipment.com
service@colmarequipment.com

 **COLMAR UK Ltd.**
U.K.
Unit 10, Wheel Forge Way
Ashburton Park
Ashburton Road West, Trafford Park
Manchester M17 1EH
Ph. **0161 848 8902**
Fax 0161 848 8903
www.colmarspa.com
colmaruk@colmarspa.com

 **ООО COLMAR БОСТОК**
RUSSIA
115088 Moscow,
Yuzhnoportovaya ul.7
Ph. +7 095 5405538
Fax +7 095 7100848
www.colmarspa.com
info@oocolmar.ru



ISO 9001 CERT. N.1579

